

27 II/28 II Digital Multimeters

Calibration Information

Introduction

Warning

To prevent electric shock or injury, do not do the performance tests or calibration adjustment procedures unless qualified to do so.

The information provided in this document is for the use of qualified personnel only.

This document provides adjustment and performance test procedures for the Fluke 27 II/28 II Digital Multimeters (the Meter or the Product).

See the *27II/28 II Users Manual* for complete operating instructions.

Contact Fluke

Fluke Corporation operates worldwide. For local contact information, go to our website: www.fluke.com.

To register your product, or to view, print, or download the latest manual or manual supplement, go to our website.

+1-425-446-5500

fluke-info@fluke.com

Safety Information

General Safety Information is in the printed Safety Information document that ships with the Product and at www.fluke.com. More specific safety information is listed where applicable.

April 2010 Rev. 1, 10/24

©2010-2024 Fluke Corporation. All rights reserved.

Specifications are subject to change without notice.

All product names are trademarks of their respective companies.

A **Warning** identifies hazardous conditions and procedures that are dangerous to the user. A **Caution** identifies conditions and procedures that can cause damage to the Product or the equipment under test.

⚠ Caution

To avoid possible damage to the Meter or to the equipment under test, follow these guidelines:

- **Disconnect circuit power and discharge all high-voltage capacitors before testing resistance, continuity, diodes, or capacitance.**
- **Use the proper terminals, function, and range for all measurements.**
- **Before measuring current, check the Meter fuses. (See [Fuse Test.](#))**

Specifications

Product specifications are in the Users Manual available at www.fluke.com.

Basic Maintenance

⚠⚠ Warning

To prevent possible electrical shock, fire, or personal injury, to avoid possible electric shock or personal injury, repairs or servicing covered in this manual should be done only by qualified personnel.

General Maintenance

Periodically wipe the case with a damp cloth and mild detergent. Do not use abrasives or solvents.

Dirt or moisture in the terminals can affect readings and can falsely activate the Input Alert feature.

To clean the terminals:

1. Turn the Meter off and remove all test leads.
2. Shake out any debris that may be in the terminals.
3. Soak a clean swab with mild detergent and water. Work the swab around in each terminal.
4. Dry each terminal with canned air to force the water and detergent from the terminals.

⚠⚠ Warning

To avoid electrical shock or personal injury, remove the test leads and any input signals before you replace the battery or fuses.

Product Disposal

Dispose of the Product in a professional and environmentally sound manner:

- Delete personal data on the Product before disposal.
- Remove batteries that are not integrated into the electrical system before disposal and dispose of batteries separately.
- If this Product has an integral battery, put the entire Product in the electrical waste.

Fuse Test

To test the fuse:

1. Put the Meter into the Ω function.
2. Insert a test lead into the Ω jack.
3. Place the probe tip on the other end of the test lead against the metal of the current input jack. See [Figure 1](#).

If **LEAD** shows on the display, the probe tip has been inserted too far into the amp input jack.

4. Back the lead out until the display message disappears and either **OL** or a resistance reading shows.

The resistance value will be as they are shown in [Figure 1](#). If the tests give readings other than those shown, have the Meter serviced.

⚠⚠ Warning

To prevent possible electrical shock, fire, or personal injury, install **ONLY** specified replacement fuses with the amperage, voltage, and speed ratings shown in [Table 6](#).

Figure 1. Current Fuse Test

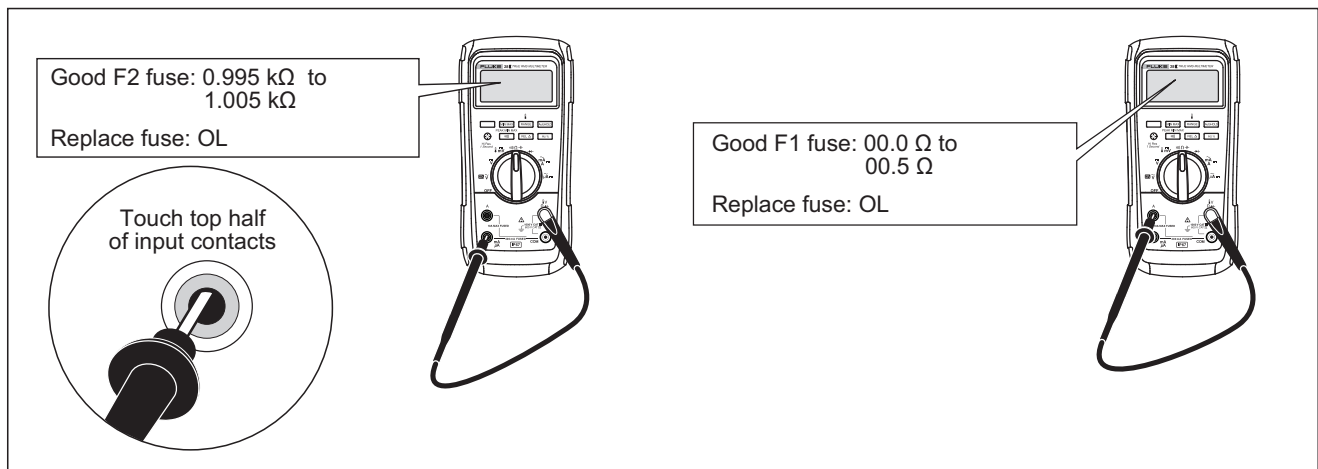



Static Awareness



Semiconductors and integrated circuits can be damaged by electrostatic discharge during handling. This notice explains how to minimize damage to these components.

1. Understand the problem.
2. Learn the guidelines for proper handling.
3. Use the proper procedures, packaging, and bench techniques.

Follow these practices to minimize damage to static sensitive parts.

Warning

To prevent electric shock or personal injury. De-energize the product and all active circuits before opening a product enclosure, touching or handling any PCBs or components.



- Minimize handling.
- Handle static-sensitive parts by non-conductive edges.
- Do not slide static-sensitive components over any surface.
- When removing plug-in assemblies, handle only by non-conductive edges.
- Never touch open-edge connectors except at a static-free work station.

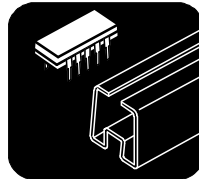

- Keep parts in the original containers until ready for use.
- Use static shielding containers for handling and transport.
- Avoid plastic, vinyl, and Styrofoam® in the work area.

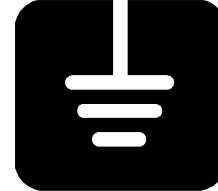

- Handle static-sensitive parts only at a static-free work station.
- Put shorting strips on the edge of the connector to help protect installed static-sensitive parts.
- Use anti-static type solder extraction tools only.
- Use grounded-tip soldering irons only.

Replace the Batteries

Warning

To prevent possible electrical shock, fire, or personal injury:

- Batteries contain hazardous chemicals that can cause burns or explode. If exposure to chemicals occurs, clean with water and get medical aid.
- Repair the Product before use if the battery leaks. Battery leakage may create a shock hazard or damage the Product.
- Do not put battery cells and battery packs near heat or fire. Do not put in sunlight.
- MSHA approved for use with three Energizer P/N E91 or three Duracell P/N MN1500 1.5 Volt, AA alkaline batteries only. All cells are to be replaced at the same time with identical part number cells in fresh air locations only.
- This multimeter is not to be used to check electrical blasting circuits.
- This multimeter is not to be connected to an electrically energized circuit in an area where permissibility is required.
- To avoid false readings, which could lead to possible electric shock or personal injury, replace the battery as soon as the battery indicator () appears. If the display shows “batt” the Meter will not function until the battery is replaced.

To replace the battery, refer to [Figure 2](#):

1. Turn the rotary switch to **OFF** and remove the test leads from the terminals.
2. Remove the six Phillips-head screws from the case bottom and remove the battery door (①).

Note

As you lift the battery door, make sure the rubber gasket stays attached to the battery compartment barrier.

3. Remove and replace the three AA Alkaline batteries (②).
4. Make sure the battery compartment gasket (③) is properly installed around the outside edge of the battery compartment barrier.
5. To replace the battery door, align the battery compartment barrier with the battery compartment, and secure the door with the six Phillips-head screws.

Replace the Fuses

⚠⚠ Warning

To prevent possible electrical shock, fire, or personal injury, install **ONLY** specified replacement fuses with the amperage, voltage, and speed ratings shown in [Table 6](#).

To examine or replace the Meter fuses, see [Figure 2](#).

1. Turn the rotary switch OFF and remove the test leads from the terminals.
2. Refer to step 2 under [Replace the Batteries](#) to remove the battery door.
3. Remove the fuse compartment seal (④) from the fuse compartment.
4. Gently lift out the fuse compartment door (⑤) from the fuse compartment.
5. To remove the fuse, gently pry one end loose, then slide the fuse out of its bracket (⑥).

The 440-mA fuse is shorter than the 10-A fuse. For correct placement of each fuse, note the marking on the printed circuit board (PCA) under each fuse.

6. To replace the fuse compartment door, align the arrow on the fuse door with the arrow on the case bottom and lower the door into the fuse compartment.
7. To replace the fuse compartment seal, align the tab on the seal with the outline on the case bottom. Make sure that the seal (④) is properly seated.
8. To reinstall the battery door, follow steps 4-6 under [Replace the Batteries](#).

Figure 2. Battery and Fuse Replacement

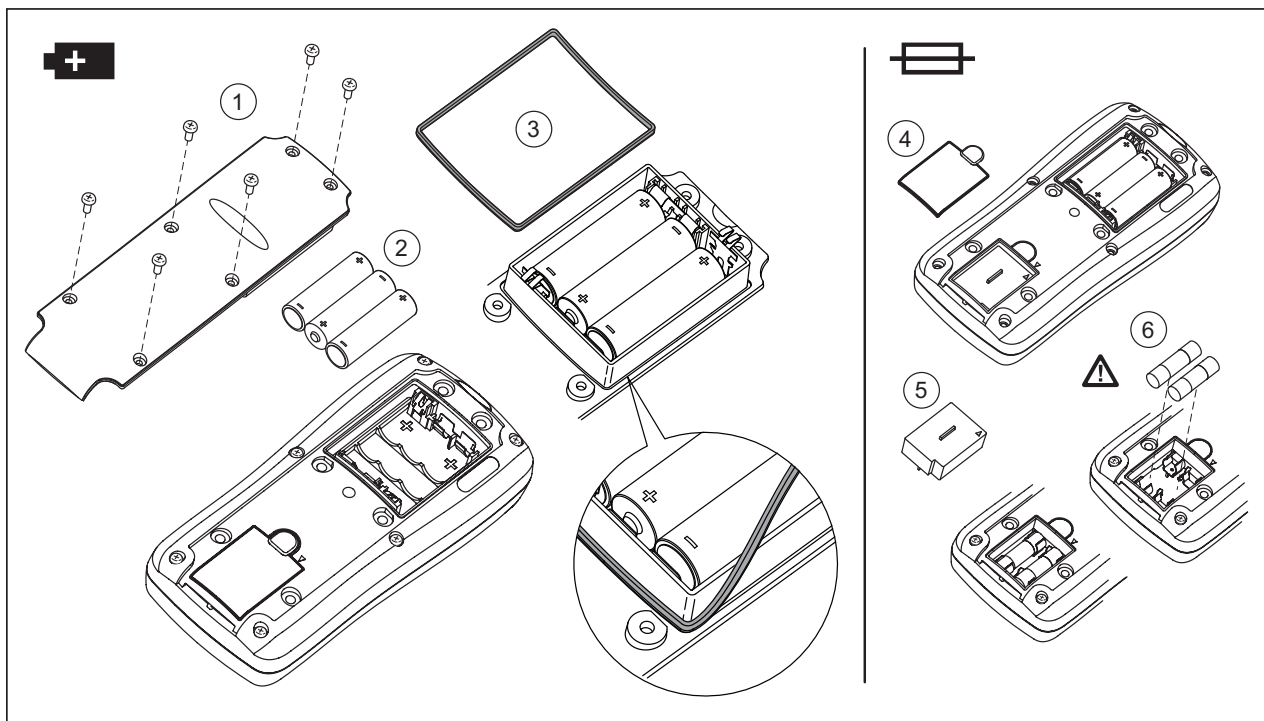

Performance Tests

Warning

To prevent electric shock, do not do the performance test procedures unless the Meter is fully assembled.

These performance tests verify the complete operation of the Meter and check the accuracy of each Meter function against its specifications. Performance tests should be performed bi-annually to ensure that the Meter is within accuracy specifications. If the Meter fails any part of the test, calibration adjustment and/or repair is indicated.

In the performance tests, the Meter is referred to as the device under test (DUT).

Required Equipment

Table 1 lists the equipment required to conduct performance tests on the Meter.

Table 1. Required Equipment

Recommended Equipment	Measurement Function	Accuracy
5520A Multi-product Calibrator (or equivalent)	DC Volts	0 V to 1000 V ± 0.012 %
	DC Current	350 μ A to 2 A ± 0.05 %
	AC Volts	0 V to 1000 V ± 0.15 % @ 60 Hz to 20 kHz ± 3 %
	AC Current	350 μ A to 2 A ± 0.39 % @ 60 Hz to 1 kHz
	Resistance	1 Ω to 100 M Ω ± 0.06 %
	Capacitance	9 μ F to 900 μ F ± 0.475 %
	Frequency	19.999 kHz to 199.99 kHz, ± 0.0137 % 150 mV to 6 Vrms, ± 5 %
K-type Thermocouple, mini-plug on both ends	Temperature	-

Test Meter Accuracy

To test the accuracy of the Meter, do the steps in [Table 2](#).

Table 2. Accuracy Tests

Step	Test Function	Range	5520A Output	Display Reading	
				27 II	28 II
1	AC Volts	600 mV	60 mV, 60 Hz	59.4 to 60.6	59.2 to 60.8
2		600 mV	330 mV, 60 Hz	328.0 to 332.0	327.3 to 332.7
3		600 mV	600 mV, 13 kHz	575.0 to 625.0	586.0 to 614.0
4		6 V	675 mV, 60 Hz	0.669 to 0.681	0.666 to 0.684
5		6 V	3.3 V, 60 Hz	3.280 to 3.320	3.273 to 3.327
6		6 V	3.3 V, 20 kHz	3.158 to 3.442	3.214 to 3.386
7		60 V	6.75 v, 60 Hz	6.69 to 6.81	6.68 to 6.82
8		60 V	33 V, 60 Hz	32.80 to 33.20	32.75 to 33.25
9		60 V	33 V, 20 kHz	31.58 to 34.42	N/A
10		60 V	33 V, 5 kHz	32.30 to 33.7	N/A
11		600 V	67.5 V, 60 Hz	66.9 to 68.1	66.8 to 68.2
12		600 V	330 V, 60 Hz	328.0 to 332.0	327.5 to 332.5
13		600 V	330 V, 2.5 kHz	323.1 to 336.9	323.0 to 337.0
14		1000 V	100 V, 60 Hz	96 to 104	97 to 103
15		1000 V	1000 V, 1 kHz	987 to 1013	986 to 1014
16	AC Volts Frequency	600 mV	150 mV, 99.95 kHz	99.93 to 99.97	99.93 to 99.97
17	AC Volts Frequency	600 mV	150 mV, 199.50 kHz	199.48 to 199.52	199.48 to 199.52
18	Sensitivity	6 V	0.7 V, 99.95 kHz	99.93 to 99.97	99.93 to 99.97
19		60 V	7 V, 99.95 kHz	99.93 to 99.97	99.93 to 99.97
20	Trigger level	6 V	3.4 V, 1 kHz Sq. Wave	999.8 to 1000.2	999.8 to 1000.2
21	Duty Cycle	6 V	5 V, 1 kHz, DC offset 2.5 V Sq. Wave	49.7 % to 50.3 %	49.7 % to 50.3 %
22	DC Volts	6 V	3.3 V dc	3.297 to 3.303	3.297 to 3.303
23		60 V	33 V dc	32.97 to 33.03	32.97 to 33.03
24		600 V	330 V dc	329.7 to 330.3	329.7 to 330.3
25		1000 V	1000 V dc	998 to 1002	998 to 1002

Table 2. Accuracy Tests (cont.)



Step	Test Function	Range	5520A Output	Display Reading	
				27 II	28 II
26	$\overline{\text{mV}}$	600 mV	50 mV dc	49.8 to 50.2	49.8 to 50.2
27	DC Volts	600 mV	330 mV dc	329.6 to 330.4	329.6 to 330.4
28	Ω Ohms	600 Ω	330 Ω (Use 2 wire Comp)	329.1 to 330.9	329.1 to 330.9
29		6 k Ω	3.3 k Ω (Use 2 wire Comp)	3.292 to 3.308	3.292 to 3.308
30		60 k Ω	33 k Ω	32.92 to 33.08	32.92 to 33.08
31		600 k Ω	330 k Ω	329.2 to 330.8	329.2 to 330.8
32		6 M Ω	3.3 M Ω	3.292 to 3.308	3.292 to 3.308
33		50 M Ω	30 M Ω	29.69 to 30.31	29.69 to 30.31
34		nS Conductance	60 nS	100 M Ω	9.60 to 10.40
35	 Diode	6 V	2.0 V dc	1.979 to 2.021	1.979 to 2.021
36	$\overline{\text{mA}} \sim$ AC Amps	6 A	3.0 A, 60 Hz	2.953 to 3.047	2.968 to 3.032
37	$\overline{\text{mA}}$ DC Amps	6 A	3.0 A	2.990 to 3.010	2.990 to 3.010
38	$\overline{\text{mA}} \sim$ AC Milliamps	60 mA	33 mA, 60 Hz	32.48 to 33.52	32.65 to 33.35
39		400 mA	330 mA, 60 Hz	324.8 to 335.2	326.5 to 333.5
40	$\overline{\text{mA}}$ DC Milliamp	60 mA	33 mA	32.89 to 33.11	32.89 to 33.11
41		400 mA	330 mA	329.1 to 330.9	329.1 to 330.9
42	$\overline{\mu\text{A}} \sim$ AC Microamps	600 μA	330 μA , 60 Hz	324.8 to 335.2	326.5 to 333.5
43		6000 μA	3300 μA , 60 Hz	3248 to 3352	3265 to 3335
44	$\overline{\mu\text{A}}$ DC Microamps	600 μA	330 μA	328.9 to 331.1	328.9 to 331.1
45		6000 μA	3300 μA	3291 to 3309	3291 to 3309
46	 Capacitance	10 nf	Open input ¹	0.28 to 0.48	0.28 to 0.48
47		100 nf	5 nf ²	4.7 to 5.3	4.7 to 5.3
48		100 μf	9.5 μf	9.2 to 9.8	9.2 to 9.8
49		1000 V	400 V, 400 Hz	N/A	372 to 408
50	Low Pass Filter - 28 II	1000 V	400 V, 800 Hz ³	N/A	226 to 340

Table 2. Accuracy Tests (cont.)

Step	Test Function	Range	5520A Output	Display Reading	
				27 II	28 II
51	VDC Peak Min/Max – 28 II	6 V	8 Vpp, 2 kHz Sq. Wave, DC offset 2 V	N/A	Min = -1.898 to -2.102 Max = 5.896 to 6.104
52	mVdc		0 °C	N/A	-1.0 to 1.0
53	Temperature ⁴ – 28 II		100 °C	N/A	98.0 to 102.0
54	Backlight		Press backlight button	Backlight comes on	Backlight comes on
55			Press backlight button	Backlight intensifies	Backlight intensifies
56			Press backlight button	Backlight goes off	Backlight goes off
<p>[1] Remove test leads from unit.</p> <p>[2] Use REL Δ to compensate for internal Meter and lead capacitance (must disconnect test leads from calibrator before you push REL Δ)</p> <p>[3] The Meter accuracy is not specified at this input signal frequency with Low-pass filter selected. The display reading shown, checks that the Low-pass filter is active and follows an expected roll-off curve.</p> <p>[4] To ensure accurate measurement, the Meter and thermocouple adapter must be at the same temperature. After you connect the thermocouple adapter to the Meter allow for reading to stabilize before recording display reading.</p>					

Calibration Adjustments

Do the calibration adjustment procedure if the Meter fails any performance tests. If the adjustment procedure is discontinued prior to completion, no changes are made to the calibration constants that are stored in memory. Below is an explanation of the pushbutton features and requirements to enter the calibration mode.



Calibration (CAL) Mode Pushbutton Functions

- The CAL mode is initiated when you hold down **MIN MAX** at power up and enter a four-digit password.
- **AutoHOLD** acts as an **ENTER** key and advances through the CAL initiation and adjustment procedure steps.
- Use the pushbuttons to select a four-digit password.

During initiation of the CAL mode, a display count shows how many times calibration constants have been written to memory.

Enter and Display the Four-Digit Password

When the Meter was manufactured it was given a default password of **1234**. These pushbuttons are used to select the password. Each pushbutton represents the indicated digit:

= 1, MIN MAX = 2, RANGE = 3, AutoHOLD = 4,  = 5,  = 6, REL Δ = 7, Hz % = 8

After you select the password, there are two choices:

- Push AutoHOLD to show $\{ -0 \}$ which indicates the correct password and successful entry. You may proceed with the first calibration step.
- Push RANGE to show $----$, which indicates the correct password, proceed to select a new password.

If the password is incorrect, the concluding AutoHOLD or RANGE push instead causes the Meter to double beep and the display to show $????$. The password entry process was unsuccessful and can be tried again or exit this mode by turning the Meter **OFF**.

Change the Password

To change the Meter password:

1. Turn the Meter Rotary Switch from OFF to VAC as you hold down MIN MAX simultaneously.
The display shows $\{ RL \}$.
2. Push AutoHOLD twice.
The display shows $????$.
3. Use the pushbuttons to select the old password (do not use AutoHOLD to save the password).
4. Push RANGE. The Meter displays $----$.
5. Use the pushbuttons to select a new password.
6. Push AutoHOLD to save the new password.

Restore the Default Password

If the password is forgotten, restore the default password (**1234**):

1. Turn the Meter Rotary Switch to **OFF**.
2. Remove the bottom case and bottom shield of the Meter.
3. Check the revision number on the printed circuit board (PCB). The board revision location is identified in [Figure 3](#) and [Figure 4](#).

If the revision number is **010**:

1. Remove the PCB from the top case.
2. Apply power to the PCB. Clip on a dc voltage between 3.5 V and 5 V at the test points marked + and - at the edge of the board. See [Figure 3](#).

Figure 3. Revision 010 Board Layout

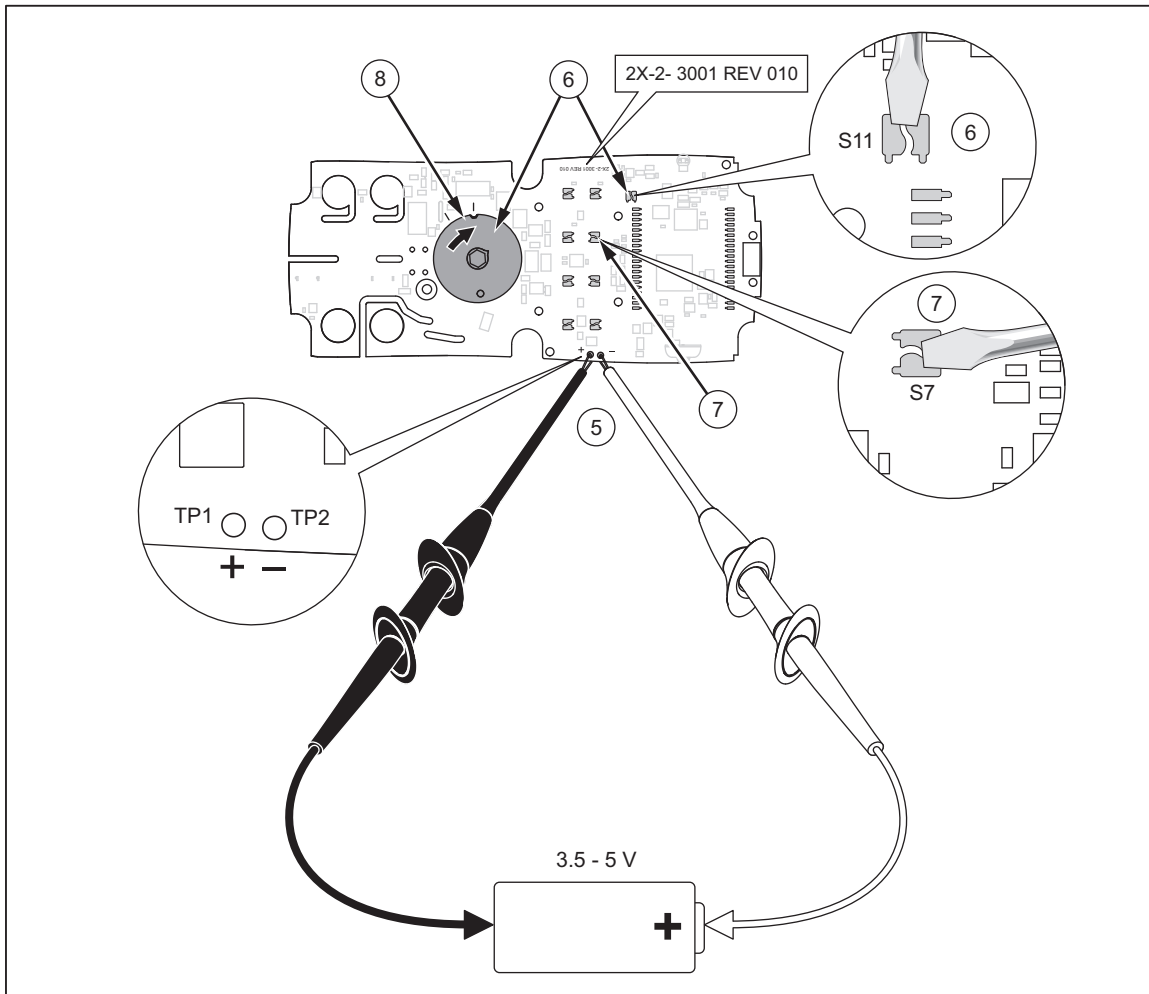

3. As you short across the keypad button S7, turn the Rotary Switch one position clockwise.
4. Short across keypad button S11.
5. Turn the rotary switch back to its original position.
The default password is now restored.
6. Reassemble the Meter before you do the adjustments or any tests.

If the revision number is **011** or higher:

1. Apply power to the PCB. Clip on a dc voltage between 3.5 V and 5 V at the test points marked + and - at the edge of the board. See [Figure 4](#).

Figure 4. Revision 011 Board Layout

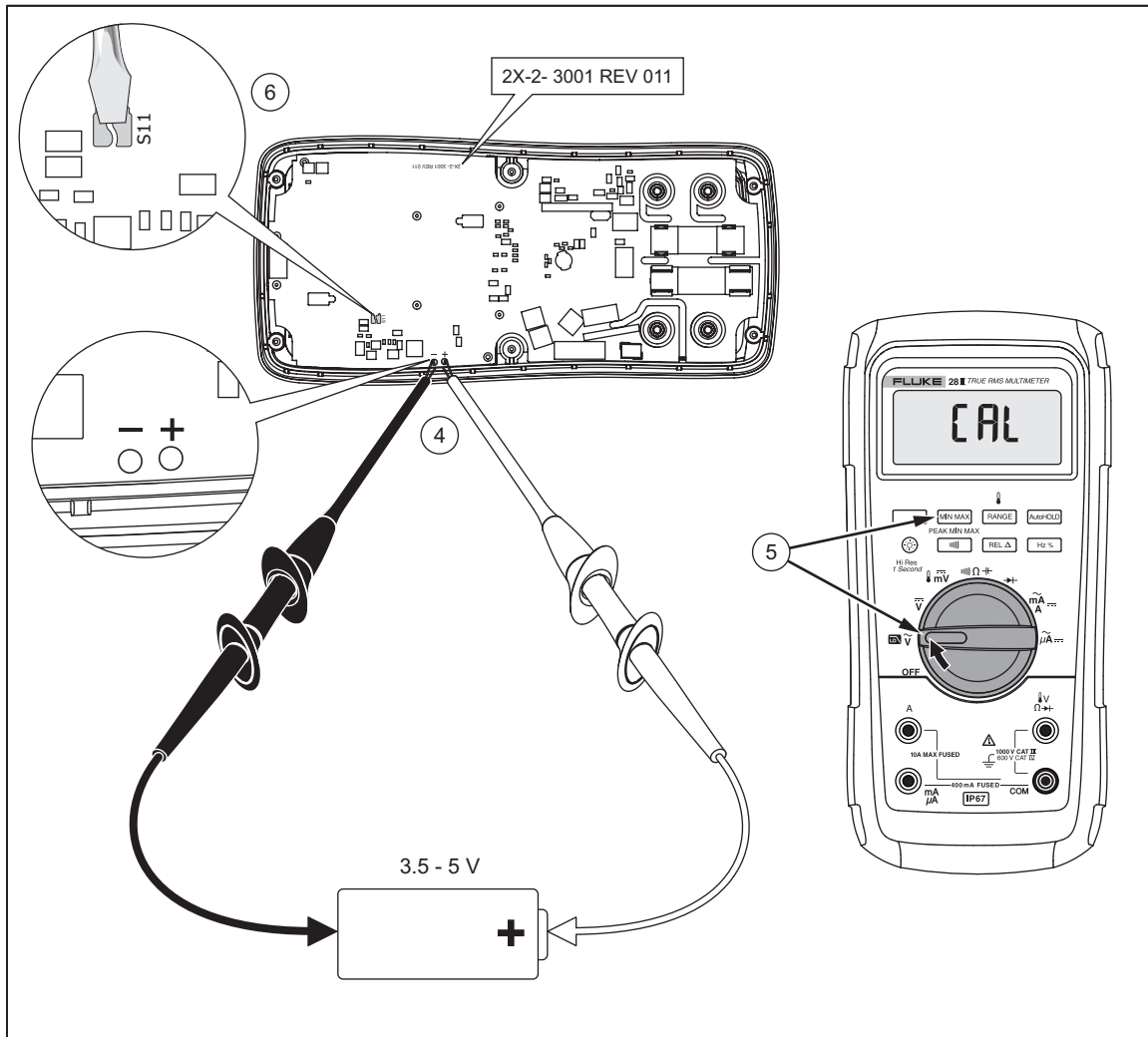





2. Turn the Rotary Switch from **OFF** to \tilde{V} as you hold down **MIN MAX** at the same time.
The Meter shows **[CAL]**.
3. Short across keypad button S11 on the back of the PCB.
The Meter beeps.
4. Turn the rotary switch to **OFF**.
The default password is now restored.
5. Reassemble the Meter before you do adjustments or any tests.

Other Pushbutton Functions

Table 3 lists and describes the Meter pushbuttons and describes what happens when pushed after the password has been entered and  is pushed.

Table 3. Pushbutton Functions During CAL Mode



Button	CAL Mode Description
 (yellow)	Push and hold to test the present function. The measurement is not calibrated so it may be inaccurate. This is normal.
	Push and hold to show the required input level.
	Push and hold to show the frequency of the input signal.
	Push to store the new calibration adjustment value and advance to the next step. Use this pushbutton to exit CAL mode after the calibration adjustment sequence is complete.

Calibration Adjustment Procedure



Some adjustment steps in this procedure take longer to execute than others (10 seconds to 15 seconds). For some of these steps the Meter gives a double beep to indicate completion. Not all steps have this feature.

1. Turn the Rotary Switch from **OFF** to  \tilde{V} as you hold down  simultaneously.

The Meter shows f [RL].

2. Push  once to see the number of completed calibrations. Push  again to enable password entry. The Meter shows $????$.
3. Use the pushbuttons to enter the existing password and then push .

The Meter shows f [-0].

Apply the value listed in Table 4 or Table 5 for each calibration step, and/or (optional) push  to show the required input signal level and push  to show the required input signal frequency.

Note

After you push , wait for the step number to advance before you change the calibrator source or turn the Meter Rotary Switch. If the reference source input is not within the required range value, the Meter double beeps and does not allow completion of the step. Before you change the Meter switch position or after you complete adjustment of each function, set the calibrator to standby. If the calibration adjustment is not completed correctly, the Meter will not operate correctly.

Table 4. 27 II Calibration Adjustment Steps

Function (Switch Position)	Adjustment Step	Input Value
\tilde{V} (AC Volts)	C-01	0 mV, 0 Hz
	C-02	6.0 mV, 60 Hz
	C-03	60.0 mV, 60 Hz
	C-04	600.0 mV, 60 Hz
	C-05	600.0 mV, 20 kHz
	C-06	6.0 V, 60 Hz
	C-07	6.0 V, 20 kHz
	C-08	60.0 V, 60 Hz
	C-09	60.0 V, 20 kHz
	C-10	600.0 V, 60 Hz
	C-11	600.0 V, 10 kHz
\overline{V} (DC Volts)	C-12	6.0 V
	C-13	60.0 V
	C-14	600.0 V
$\downarrow \overline{mV}$ (DC Millivolts)	C-15	600.0 mV
	C-16	60.00 mV
Ω (Ohms)	C-17	600.0 Ω
	C-18	6.000 k Ω
	C-19	60.00 k Ω
	C-20	600.0 k Ω
	C-21	6.000 M Ω
	C-22	0.000 Ω
	C-23	50.0 M Ω
$\rightarrow \text{+}$ (Diode Test)	C-24	3.000 V
\overline{mA} \overline{A} (Amps)	C-25	0.000 A, 0 Hz
	C-26	60.0 mA 60 Hz
	C-27	6.0 A, 60 Hz
	C-28	6.0 A, 0 Hz

Table 4. 27 II Calibration Adjustment Steps (cont.)



Function (Switch Position)	Adjustment Step	Input Value
 (Milliamps)	C-29	0.0 mA, 0 Hz
	C-30	600.0 μ A, 60 Hz
	C-31	6.0 mA, 60 Hz
	C-32	60.0 mA, 60 Hz
	C-33	400.0 mA, 60 Hz
	C-34	60.0 mA, 0 Hz
	C-35	400.0 mA, 0 Hz
 (Microamps)	C-36	0.0 μ A AC, 0 Hz
	C-37	30.0 μ A, 60 Hz
	C-38	60.0 μ A, 60 Hz
	C-39	600.0 μ A, 60 Hz
	C-40	6000.0 μ A, 60 Hz
	C-41	600.0 μ A, 0 Hz
	C-42	6000.0 μ A, 0 Hz

Table 5. 28 II Calibration Adjustment Steps



Function (Switch Position)	Adjustment Step	Input Value
 (AC Volts)	C-01	600.0 mV, 60 Hz
	C-02	600.0 mV, 20 kHz
	C-03	6.000 V, 60 Hz
	C-04	6.000 V, 20 kHz
	C-05	60.00 V, 60 Hz
	C-06	60.00 V, 20 kHz
	C-07	600.0 V, 60 Hz
	C-08	600.0 V, 10 kHz
 (DC Volts)	C-09	6.000 V
	C-10	60.00 V
	C-11	600.0 V
 (DC Millivolts)	C-12	600.0 mV
	C-13	60.00 mV

Table 5. 28 II Calibration Adjustment Steps (cont.)

Function (Switch Position)	Adjustment Step	Input Value
Ω (Ohms)	C-14	600.0 Ω
	C-15	6.000 kΩ
	C-16	60.00 kΩ
	C-17	600.0 kΩ
	C-18	6.000 MΩ
	C-19	0.000 Ω
	C-20	50.0 MΩ
→ (Diode Test)	C-21	3.000 V
$\tilde{\text{mA}}$ A (Amps)	C-22	6.000 A, 60 Hz
	C-23	6.000 A dc
$\tilde{\text{mA}}$ A (Amps)	C-24	60.00 mA, 60 Hz
	C-25	400.0 mA, 60 Hz
	C-26	60.00 mA dc
	C-27	400.0 mA dc
$\tilde{\mu\text{A}}$ (Microamps)	C-28	600.0 μA, 60 Hz
	C-29	6000 μA, 60 Hz
	C-30	600.0 μA dc
	C-31	6000 μA dc

Disassemble the Meter

To disassemble the Meter, see [Figure 5](#):

1. Place the Meter face down.
2. Use a Phillips screwdriver (the screwdriver) to remove the six battery-door screws (H1).
3. Lift the battery door (MP1) at the top end of the Meter and remove it from the case back.
4. Remove all batteries.
5. Remove the fuse access door (MP4).
6. Remove the fuse cap (MP5).
7. Use the screwdriver to remove the bottom-case screws (H2) with their O-rings (H3).
8. Separate the bottom case (MP6) from the top case (MP19).
9. Use the screwdriver to remove the bottom-shield screw (H4).
10. Remove the Meter bottom shield (MP9).

11. Use the screwdriver to remove four Printed Circuit Assembly (PCA) input screws (H5).
12. Use the screwdriver to remove six PCA screws (H4) from the board.
13. Remove the PCA from the top case.
14. Remove the top shield (MP13) from the top case.
15. Remove the elastomeric (MP10) from the top shield.
16. Unsnap mask (MP15) from the top shield (MP13).
17. Remove the LCD (DS1) from the top shield.
18. Remove the backlight (MP14) from the top shield.
19. Remove the keypad (MP18) from the top case.
20. Remove the RSOB spacer (MP16) from the top case.
21. Remove the E-clip holding the spring detent (MP17) from the top case.
22. Remove the sprint detent from the top case.
23. Remove the knob (MP20) from the top case.

Reassemble the Meter

Note

Before you reassemble the Meter, read [How to Retain the IP67 Rating](#).

To reassemble the Meter, do the disassembly steps in the reverse order.

How to Retain the IP67 Rating

This section identifies parts of the Meter that can compromise the IP67 rating due to leakage if assembly instructions are not carried out carefully.

1. **Knob:** The knob has an overmold seal that fits tight against the top case. This area must be lubricated, and the lubrication must be spread evenly around the seal area.
2. **E-clip:** Make sure it is installed correctly.
3. **Keypad:** The keypad must be correctly seated, and all six board screws tightened to 6 in-lbs torque.

4. **Bottom Case Gasket:** The gasket must be installed so that the gasket does not have any twists, bends, waves, or distortions. The gasket must be completely flat in the bottom case groove. To accomplish this, use a modified top case to push the gasket into position.
5. **Battery Door Gasket:** Place the gasket over the battery compartment walls and push each corner down as far as they will go. Install the battery door screws with 6 in-lbs torque.
6. **Fuse Access Door:** Place onto bottom case and wiggle it to make sure it is fully seated. Install the battery door screws with 6 in-lbs torque.
7. **Case Screw O-ring:** Torque case screws to 12 in-lbs torque. Verify that the o-rings are not sticking out of the sides of the screw head.

Note

To ensure your Meter meets the IP67 rating, return the Meter to a qualified Fluke Service Center.

Replacement Parts

Table 6 lists replaceable parts of the Meter that are identified in [Figure 5](#).

Figure 5. Exploded View

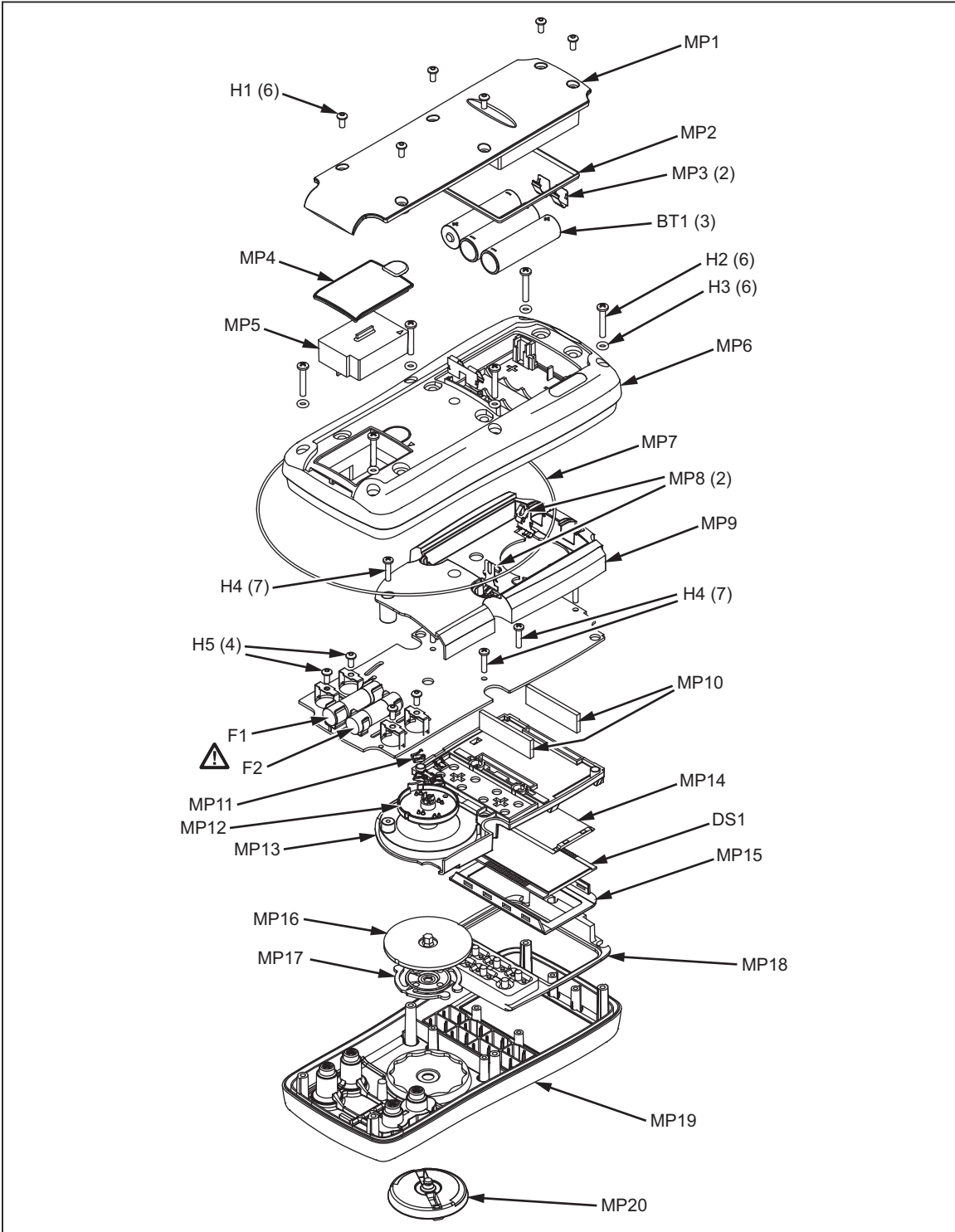

Table 6. Replacement Parts

Item	Description	Part Number	Qty.
BT1	BATTERY,PRIMARY,ZNMNO2,1.5V,2.24AH,15A,LR6,ALKALINE,AA,14X50MM,BULK	376756	3
DS1	LCD,4.5 DIGIT,TN,TRANSFLECTIVE,BAR GRAPH,OSPR80,FLUKE-87-5	2065213	1
F1	 FUSE,11A,1000V,FAST.406INX1.5IN,BULK	803293	1
F2	 FUSE,.440 A,1000V,FAST.406INX1.5IN,BULK	943121	1
H1	SCREW,M3X0.5,6MM,PAN,PHILLIPS,STEEL,ZINC-BLACK CHROMATE	2032792	6
H2	SCREW,5-14,.750,PAN,HEXALOBULAR,STEEL,ZINC-BLK CHROMATE,BLUNT PT,THREAD FORM	1558745	6
H3	O-RING,NITRILE,INT LUBE,SHORE A 70,AS 568A-006,.114 ID,.070 W	705947	6
H4	SCREW,4-14,.510,PAN,PHILLIPS,STEEL,ZINC-CHROMATE,THREAD CUT	853668	7
H5	SCREW,M3X0.5,6MM,PAN,PHILLIPS,STEEL,ZINC-CHROMATE	2743764	4
MP1	FLUKE-2X-2-2010,BATTERY DOOR, WITHOUT BATTERY CONTACTS	3321030	1
MP2	FLUKE-2X-II-8007,GASKET, BATT DOOR, FLUKE 27-II AVG AND FLUKE 28-II TRMS METERS	3439087	1
MP3	FLUKE 89-4-8012 ,BATTERY CONTACT, DUAL	666435	2
MP4	FLUKE-2X-2-2014,FUSE ACCESS DOOR, 27-2 AVG AND 28-2 TRMS MULTIMETER	3400480	1
MP5	FLUKE-2X-2-2015,FUSE CAP	3440546	1
MP6	FLUKE-2X-2-2004,CASE, BOTTOM WITHOUT BATTERY CONTACTS	3320869	1
MP7	FLUKE 2X-II-8006,GASKET, TOP CASE, FLUKE-27-II AVG AND FLUKE-28-II TRMS METERS	3439079	1
MP8	SHENGUANG-8012,BATTERY CONTACT SHENGUANG	3324731	2
MP9	FLUKE-2X-2-8002,BOTTOM SHIELD, FLUKE 27-2 AVG / FLUKE 28-2 TRMS MULTIMETER	3371942	1
MP10	CONNECTOR,ELASTOMERIC,.375 HIGH,.10 THICK,1.59 LONG,BULK	5610605	2
MP11	FLUKE-17X-8001,CONTACT, RSOB	3084560	4
MP12	FLUKE 87-5-2009,HOUSING, RSOB	2073945	1

Table 6. Replacement Parts

Item	Description	Part Number	Qty.
MP13	FLUKE-2X-2-8001, TOP SHIELD, FLUKE 27-2 AVG / FLUKE 28-2 TRMS MULTIMETER	3371939	1
MP14	FLUKE-2X-2-8009, BACKLIGHT, FLUKE 27II / FLUKE 28II MULTIMETER	3471251	1
MP15	FLUKE-27-2-2501-04, MASK, LCD (PAD XFER), (for 27-2)	3400020	1
	FLUKE-28-2-2501-05, MASK, LCD (PAD XFER) (for 28-2)	3400047	1
MP16	FLUKE-2X-2-2007, SPACER, RSOB	3320891	1
MP17	FLUKE-2X-2-2008, DETENT, SPRING	3320905	1
MP18	FLUKE-2X-8003, KEYPAD, FLUKE 27-2 AND FLUKE 28-2	3359962	1
MP19	FLUKE-27-2-2501, TOP CASE, PAD XFER (For 27-2)	3441368	1
	FLUKE-28-2-2502, TOP CASE, PAD XFER (for 28-2)	3320857	1
MP20	FLUKE-2X-2-2009, ROTARY KNOB	3320922	1
Not Shown	FLUKE-2X-2-2011, HOLSTER w/Tilt Stand	3321048	1
Not Shown	TL75-4201, TEST LEADS	855742	1
Not Shown	80BK-A-8001, TYPE K THERMOCOUPLE ASSEMBLY (for 28-2)	2747900	1
Not Shown	FLUKE 87-5-8009, TILTSTAND	2074040	1
Not Shown	27 II / 28 II Getting Started Manual	3368142	1
Not Shown	27 II / 28 II Users Manual CD	3368139	1

Lifetime Limited Warranty

Each Fluke 20, 70, 80, 170, 180 and 280 Series DMM will be free from defects in material and workmanship for its lifetime. As used herein, "lifetime" is defined as seven years after Fluke discontinues manufacturing the product, but the warranty period shall be at least ten years from the date of purchase. This warranty does not cover fuses, disposable batteries, damage from neglect, misuse, contamination, alteration, accident or abnormal conditions of operation or handling, including failures caused by use outside of the product's specifications, or normal wear and tear of mechanical components. This warranty covers the original purchaser only and is not transferable. For ten years from the date of purchase, this warranty also covers the LCD. Thereafter, for the lifetime of the DMM, Fluke will replace the LCD for a fee based on then current component acquisition costs.

To establish original ownership and prove date of purchase, please complete and return the registration card accompanying the product or register your product on <http://www.fluke.com>. Fluke will, at its option, repair at no charge, replace or refund the purchase price of a defective product purchased through a Fluke authorized sales outlet and at the applicable international price. Fluke reserves the right to charge for importation costs of repair/replacement parts if the product purchased in one country is sent for repair elsewhere.

If the product is defective, contact your nearest Fluke authorized service center to obtain return authorization information, then send the product to that service center, with a description of the difficulty, postage and insurance prepaid (FOB Destination). Fluke assumes no risk for damage in transit. Fluke will pay return transportation for product repaired or replaced in-warranty. Before making any non-warranty repair, Fluke will estimate cost and obtain authorization, then invoice you for repair and return transportation.

THIS WARRANTY IS YOUR ONLY REMEDY. NO OTHER WARRANTIES, SUCH AS FITNESS FOR A PARTICULAR PURPOSE, ARE EXPRESSED OR IMPLIED. FLUKE SHALL NOT BE LIABLE FOR ANY SPECIAL, INDIRECT, INCIDENTAL OR CONSEQUENTIAL DAMAGES OR LOSSES, INCLUDING LOSS OF DATA, ARISING FROM ANY CAUSE OR THEORY. AUTHORIZED RESELLERS ARE NOT AUTHORIZED TO EXTEND ANY DIFFERENT WARRANTY ON FLUKE'S BEHALF. Since some states do not allow the exclusion or limitation of an implied warranty or of incidental or consequential damages, this limitation of liability may not apply to you. If any provision of this warranty is held invalid or unenforceable by a court or other decision-maker of competent jurisdiction, such holding will not affect the validity or enforceability of any other provision.

5/07

Fluke Corporation
6920 Seaway Blvd.
Everett, WA 98203
U.S.A.

Fluke Europe B.V.
P.O. Box 1186
5602 BD Eindhoven
The Netherlands

